

Servis karta

10.11.2020.

Name	SALERNO
Typ	T 65 - STOLIĆ

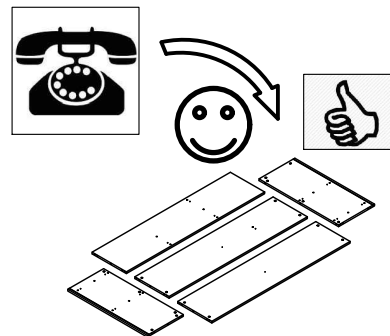
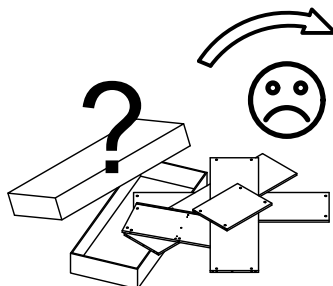
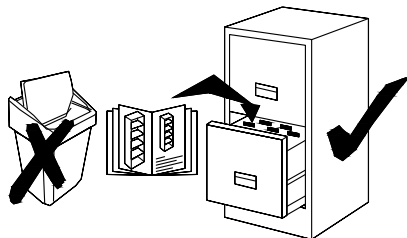

- ① 1150×654×38
- ② 1102×634×19
- ③ 160×160×19
- ④ 550×160×19
- ⑤ 645×412×40

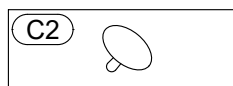
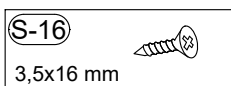
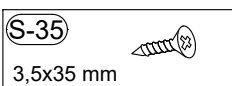
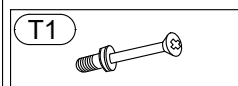
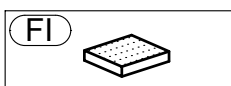
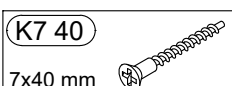
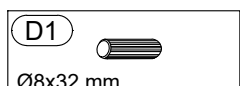
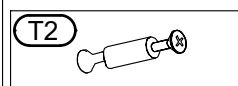
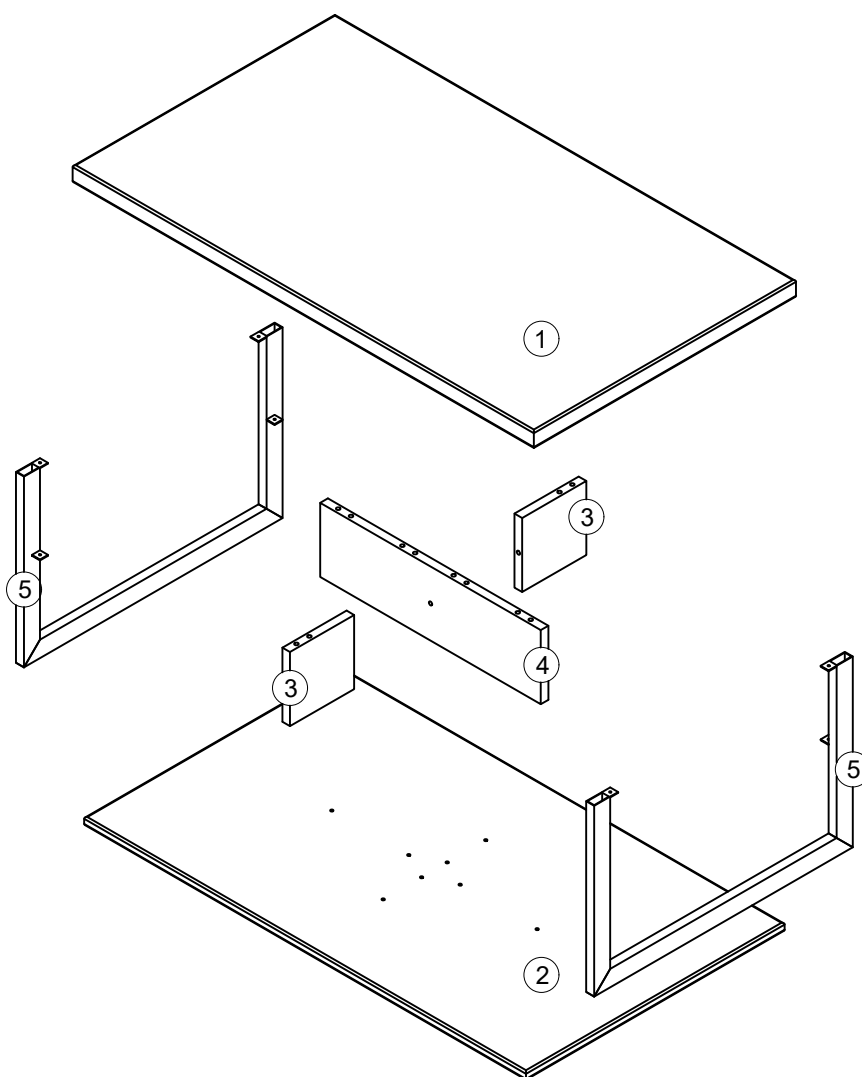

SALERNO

UPUTA ZA MONTAŽU TIP T65 - STOLIĆ

10.11.2020.

1/1



1 OSOBA

10
Min.

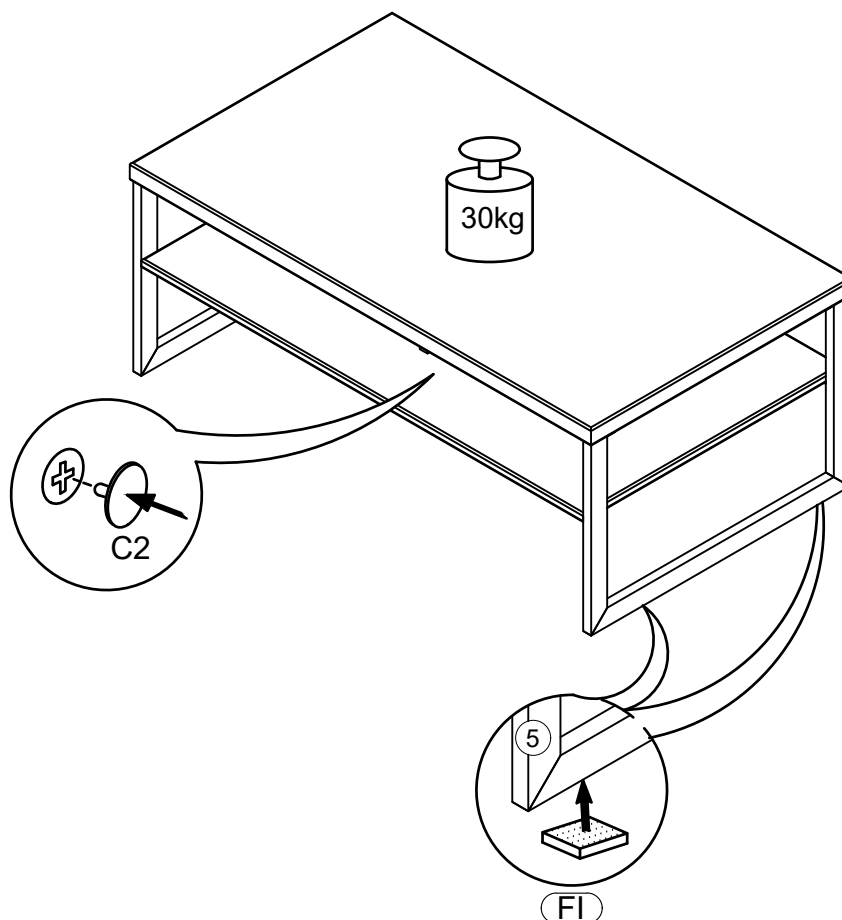
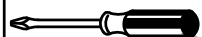

FI



x4

C2



x8